

Article number: 203160M16125B3TK
 Description: E+G levelling foot
 GN 31-60-M16-125-B3-TK
 Note: TK With nut, Wrench flat at the bottom

Measures

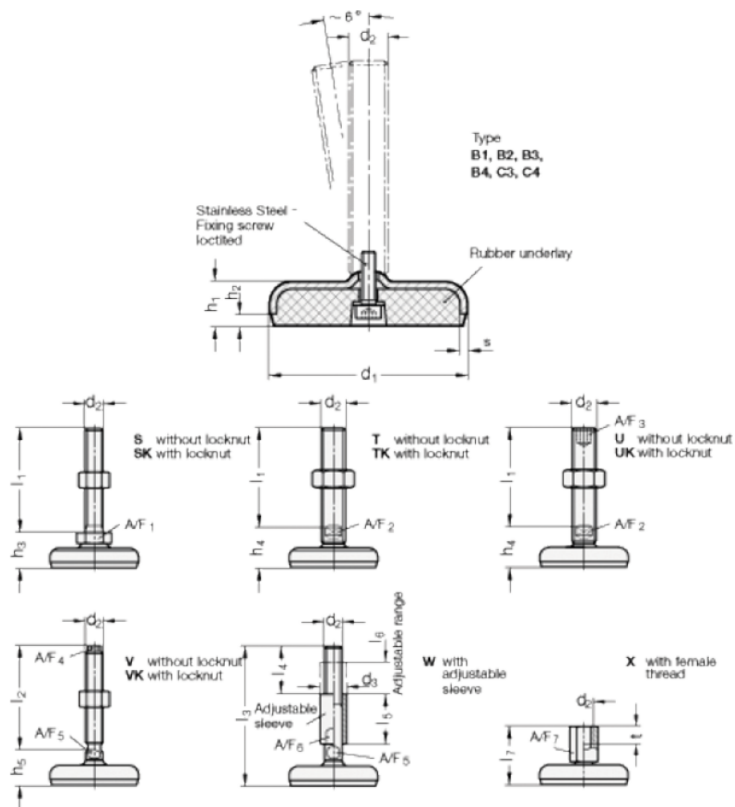

A/F2	=	12
d1	=	60
d2	=	16
h1	=	16
h2	=	4
h4 +4.0/0	=	30
l2	=	125
s	=	3